



## K-SUPPLY

K-BUS power supply for K-Series modules

### General Description

The K-SUPPLY module permits the delivery of power supply to numerous K-Series modules through K-BUS connection by creating interface between an external power supply system and the user module distribution bus. The impossibility of tapping current from the bus to the input terminals permits the connection of numerous K-SUPPLY modules in parallel on the same bus together with the protection provided against polarity inversion permits the module to offer valid protection against erroneous connections.

Main features:

- two independent inputs that permit the use of one power supply system; redundant power supply that guarantees the presence of power supply even whenever the source of either input undergoes power failure;
- indication of the presence of each channel: the LED switches on only when there is sufficient voltage for the operation of the K-Series modules connected;
- a LED that signals input inverted polarity or alternating current;
- built-in over-voltage (surge) protection;
- differential mode filter.

### Technical features

#### Input characteristics

Number:	2, with shared negative terminal.
Type:	Pass-through: each input can be accessed by two pairs of terminals, in this way permitting the same power supply source to be used for more than one K-Supply module (see the section entitled <b>Example of Connection to more than one bus</b> ).
Voltage:	19,2..30 Vdc
Current carrying capacity:	Maximum current per terminal: 4 A
Protection:	Each positive input must be provided with protection by an external fuse (see the section entitled <b>Fuse Sizing Selection</b> ). The device has no limit on maximum current.

<b>Output characteristics</b>	
Maximum voltage drop:	300 mV
Voltage :	Input voltage minus internal voltage drooping value.
Current carrying capacity:	One single input: maximum 1.6 A Inputs 1 and 2 connected in parallel: maximum 2 A.

<b>Other electrical characteristics</b>	
Filter:	Differential mode, equal to 4.7 mH & 2 x 470 nF per input.
Power Consumption:	Maximum 5 mA per input.
Dissipation:	Maximum 600 mW at peak load.

<b>General technical characteristics</b>	
Protection:	IP20
Environmental conditions:	Temperature: -20 ... +65°C Humidity: 10 ... 90% non-condensing Altitude: up to 2000 m. a. s. l.
Storage temperature:	-40..+85°C
Connections:	Cable clamp terminals
Wire section:	0,2..2,5 mm <sup>2</sup>
Wire stripping:	8 mm
Box :	PBT, black
Dimensions and weight :	6,2 x 93,1 x 102,5 mm, 46 g.
Reference standards :	EN61000-6-4/2002 (electromagnetic emission, industrial environment) EN61000-6-2/2002 (electromagnetic immunity, industrial environment) EN61010 (electrical safety)
	

## Installation rules

This module has been designed for assembly on a DIN 46277 rail. Assembly in vertical position is recommended in order to increase the module's ventilation, and no raceways or other objects that compromise aeration must be positioned in the vicinity.

Do not position the module above equipment that generates heat; we recommend positioning the module in the lower part of the control panel or container compartment.

### Inserting the module in the rail

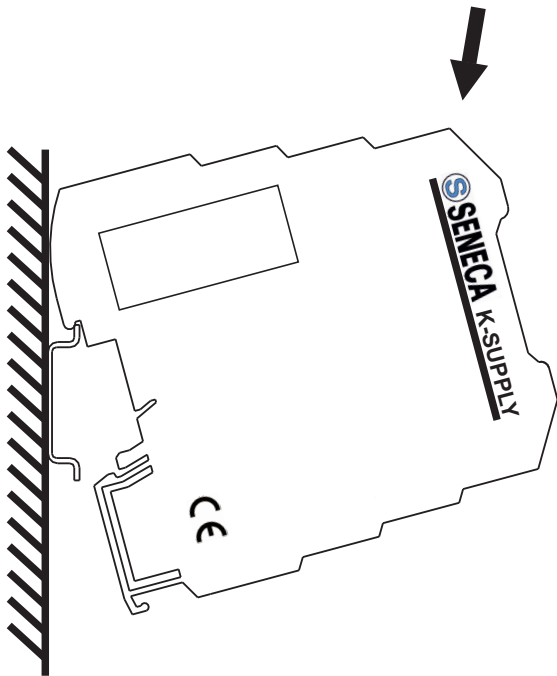

- 1 - Attach the module in the upper part of the rail.
- 2 - Press the module downwards.

### Removing the module from the rail

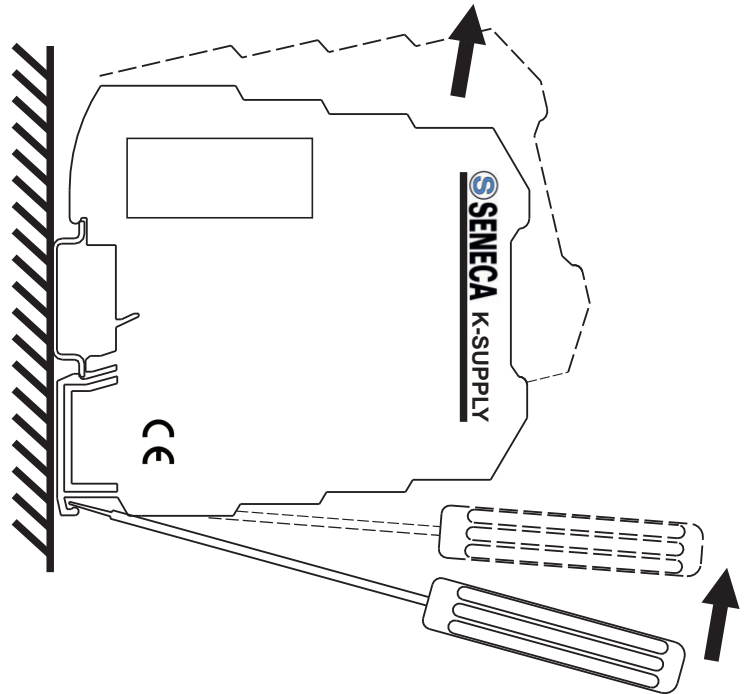

- 1 - Apply leverage using a screwdriver (as shown in the figure).
- 2 - Rotate the module upwards.

## Using the K-BUS connector

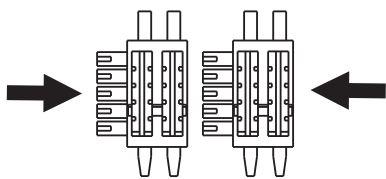

- 1 - Compose the K-BUS connectors as required in order to obtain the number of positions necessary (each K-BUS permits the insertion of no. 2 modules).
- 2 - Insert the K-BUS connectors in the rail by positioning them on the upper side of the rail and then rotating them downwards.

**IMPORTANT:** Pay particular attention to the position of the protrudent terminals of the K-BUS. The K-bus must be inserted in the guide with the protrudent terminals on the left (as shown in the figure) otherwise the modules are turned upside down.

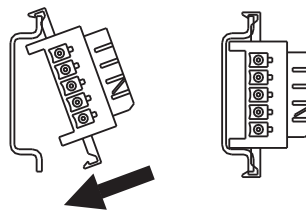

- Never connect the power supply directly to the bus connector on the DIN rail.
- Never tap power supply from the bus connector either directly or by using the module's terminals.

## ***Fuse sizing selection***

This section provides indications on the sizing of the fuse to be used for the protection of the inputs as required by the number of boards that the K-SUPPLY module must power.

The table below provides the sizing recommended per type of fuse for battery-powered systems (21...30 V) in which surge is not foreseen.

Numbers of modules	Rapid type	Average type	Delayed type
2	–	100 mA	100 mA
5	–	200 mA	200 mA
10	–	400 mA	400 mA
20	750 mA	630 mA	630 mA
35	1250 mA	1250 mA	–
50	1600 mA	1600 mA	–
70	2500 mA	–	–

The table below provides the sizing recommended for systems in which surge is foreseen with 23 to 30V voltage.

Numbers of modules	Rapid type	Average type	Delayed type
2	–	–	300 mA
5	–	–	300 mA
10	–	–	300 mA
20	–	600 mA	500 mA
35	1250 mA	1 A	–
50	1500 mA	1250 mA	–
70	2 A	1600 mA	–
100	2500 mA	–	–

## Electrical connections

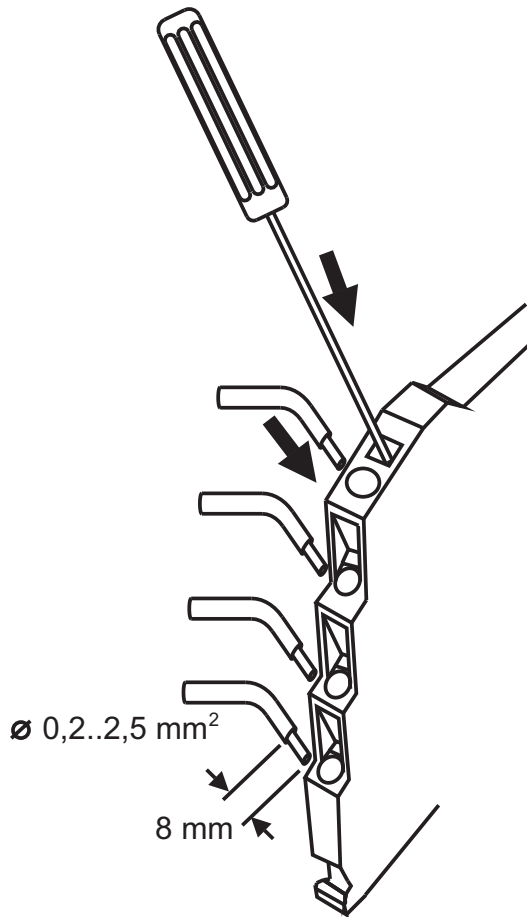

## Internal wiring diagram

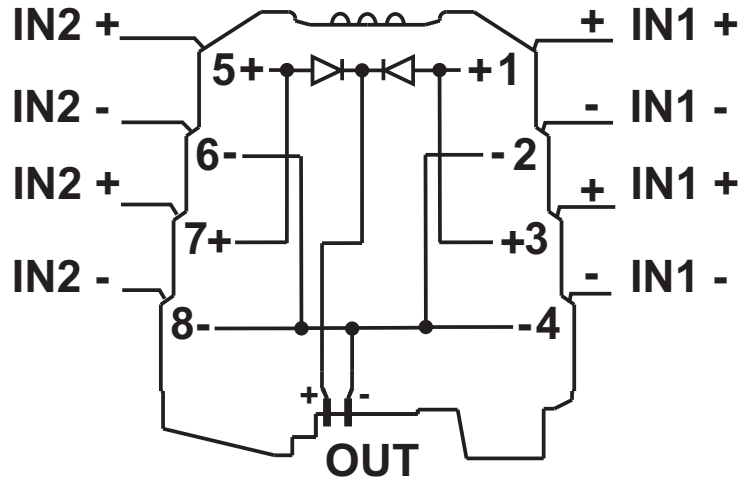

## Inputs

The module has two inputs (19.2...30V DC) with shared negative terminal.

### Input 1

Terminal 1 & Terminal 3: +  
Terminal 2 & Terminal 4: -

### Input 2

Terminal 5 & Terminal 7: +  
Terminal 6 & Terminal 8: -

Terminals 2, 4, 6, and 8 are connected together.

## Output

The module provides a K-BUS output equal to the input voltage minus the internal drooping value. The negative terminal is shared by input terminals 2, 4, 6 and 8. The module does not permit the tapping of current from the bus to the input terminals.

## Example of connection with REDUNDANT POWER SUPPLY

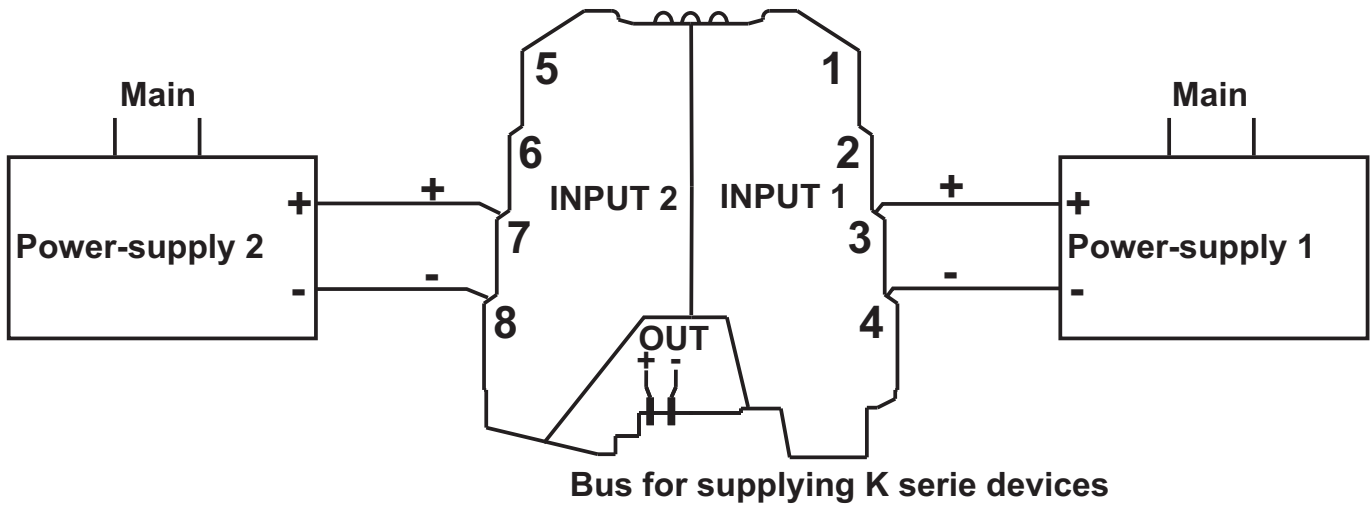

## Example of connection to more than one bus

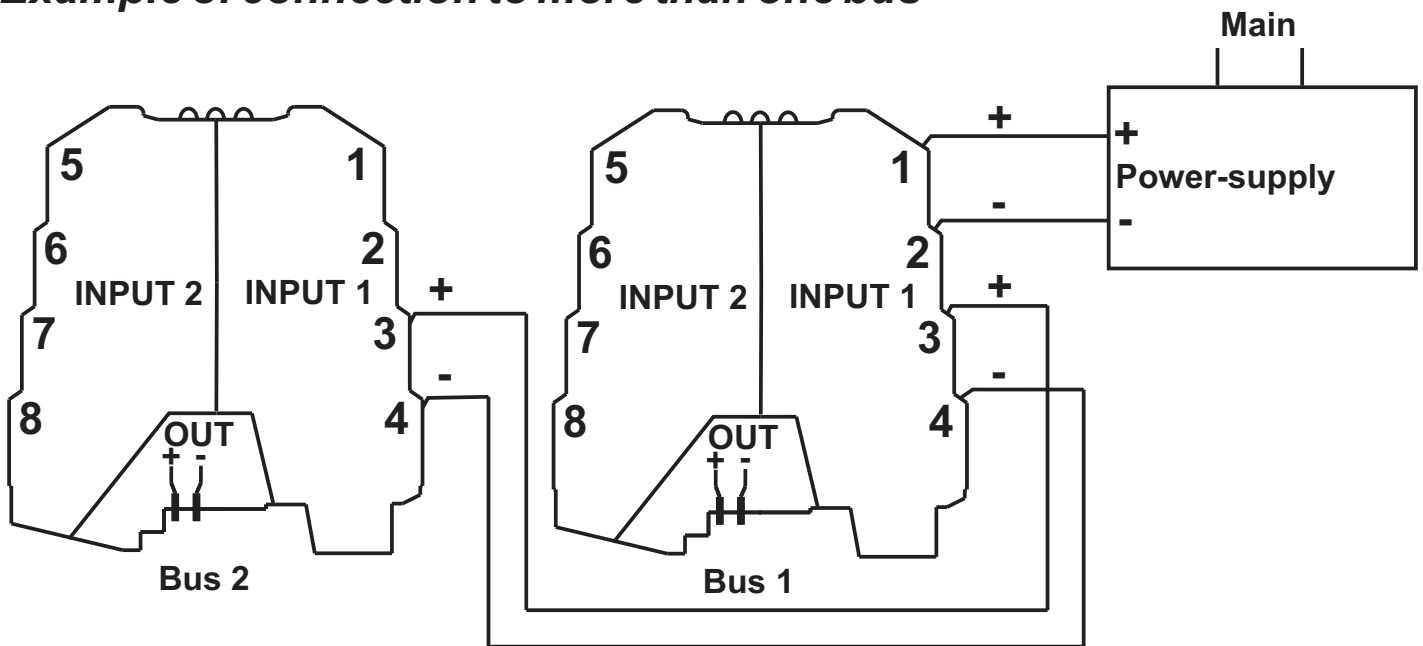

## Example of connection with inputs connected in parallel: 2 A output

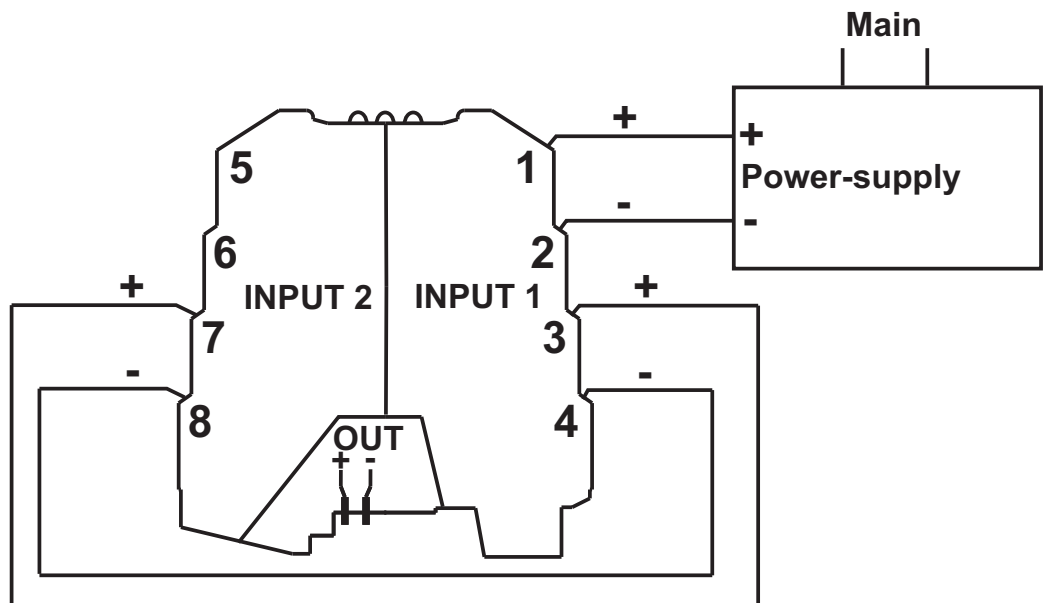

## ***Signalling by LED on the front panel***

LED	Meaning
Green Led 1	When illuminated, this LED signals the presence of sufficient voltage for the first input. The illumination threshold is $19.2\text{ V} \pm 0.3\text{ V}$
Green Led 2	When illuminated, this LED signals the presence of sufficient voltage for a second input. The illumination threshold is $19.2\text{ V} \pm 0.3\text{ V}$ .
Red Led	When illuminated, this LED signals erroneous input polarity or alternating current. The illumination threshold is 2V.



Disposal of Electrical & Electronic Equipment (Applicable throughout the European Union and other European countries with separate collection programs)

This symbol, found on your product or on its packaging, indicates that this product should not be treated as household waste when you wish to dispose of it. Instead, it should be handed over to an applicable collection point for the recycling of electrical and electronic equipment. By ensuring this product is disposed of correctly, you will help prevent potential negative consequences to the environment and human health, which could otherwise be caused by inappropriate disposal of this product. The recycling of materials will help to conserve natural resources. For more detailed information about the recycling of this product, please contact your local city office, waste disposal service or the retail store where you purchased this product.

This document is property of SENECA srl. Duplication and reproduction are forbidden, if not authorized. Contents of the present documentation refers to products and technologies described in it. All technical data contained in the document may be modified without prior notice Content of this documentation is subject to periodical revision.



**SENECA s.r.l.**

Via Austria, 26 - 35127 - PADOVA - ITALY

Tel. +39.049.8705355 - 8705359 - Fax +39.049.8706287

e-mail: [info@seneca.it](mailto:info@seneca.it) - [www.seneca.it](http://www.seneca.it)